

SUPPLEMENT 3

TALAT Lecture 3210

Continuous casting of aluminium

27 pages, 23 figures

Basic Level

prepared by Dr. –Ing. Catrin Kammer, Goslar

Objectives:

This chapter gives an overview about the possibilities to produce aluminium foilstock and wire-bar in a continuous way. Continuous casting is the preferred casting method in modern plants because it offers higher productivity. But there are limitations in the use of this technology because not all alloys can be cast. The product show properties that can differ from conventional material.

The chapter will show

- the principal of operation
- technologies for continuous casting
- types of casters
- areas of application
- properties of the products
- behaviour of the products in further processing

Prerequisites:

- General knowledge in materials engineering
- Some knowledge about aluminium alloy constitution and heat treatment
- Engineering background in manufacturing processes
- Basic knowledge of foundry practice

Date of issue 1999

European Aluminium association

3210 Continuous casting of Aluminium

Contents

3210 Continuous casting of Aluminium	2
3210.01 Introduction.....	3
3210.02 Strip casting.....	3
3210.03 Wire bar casting.....	5
3210.04 Distinguishing features of continuous casting technologies	6
3210.05 Twin drum casters	9
3210.05.01 Vertical casting direction	9
<i>a) Vertical downward - Hazelett Sr. (1930 – 1940).....</i>	<i>9</i>
<i>b) Vertical upward - Hunter Engineering.....</i>	<i>9</i>
3210.05.02 Casters with horizontal casting direction	10
<i>a) Scal, Alusuisse I, Jumbo 3C.....</i>	<i>10</i>
<i>b) The development of the Jumbo 3C to the Jumbo 3CM thin roll caster</i>	<i>12</i>
<i>c) Casting direction at an angle - The FATA Hunter SpeedCaster</i>	<i>13</i>
3210.06 Single drum casters.....	14
3210.07 Block casters.....	15
3210.07.01 Hunter-Douglas (Block caster)	15
3210.07.02 Alusuisse Caster II	16
3210.08 Belt casting techniques	16
3210.08.01 Hazelett Caster	16
3210.08.02 Kaiser Caster	17
3210.09 Casters with a combination of a rotating steel belt and a water-cooled casting wheel.....	19
3210.09.01 Properzi-Caster	19
3210.09.02 The Rigamonti and the Rotary Caster.....	20
3210.10 Structure and properties of strip castings	20
3210.11 Behaviour of strip castings in further processing (rolling, thermal treatment)	22
3210.11.01 Cold rolling	22
3210.11.02 Deep drawing	24
3210.11.03 Recrystallization	24
3210.12 Literature.....	26
3210.13 List of Figures.....	27

3210.01 Introduction

Due to its many economic advantages the continuous casting of aluminium has become more and more important during the last 40 years. These processes are mostly used for the production of a semifabricated strip, for cold rolling to foilstock building sheet and canstock. They are also used to cast endless wire bar stock.

Continuous casting processes converts molten aluminium alloys directly into an endless coiled strip suitable for cold rolling or wire-bars for wire-drawing. They effectively eliminate the operations associated with traditional mould casting (discontinuous process) or D.C. casting (a semicontinuous process) and subsequent hot mill deformation. Therefore the capital investment and operational costs are significantly lower than in a conventional production process. Continuous casting is the preferred casting method in many modern plants because it offers higher productivity. Continuous casting has been employed with increasing commercial success for aluminium as well as other metals.

Among the continuous casting technologies the strip casting processes now account for a remarkable share of the worlds output of rolled aluminium semifabricated coilstock (approximately 30%).

While strip casting will be the main topic of this chapter, the technology for the production of wire bar will also be described. Semicontinuous processes (DC casting) are discussed in [Lecture 1301](#).

3210.02 Strip casting

Continuous strip casting has proved itself for the production of foilstock, of strip for painting and – in some cases – of strip for deep drawing processes. The various strip casting technologies are suitable for the casting of wrought alloys and allow the production of strip from 3 mm to 20 mm thickness and up to 2150 mm width.

[Figure 3210.02.01](#) illustrates the main feature of all continuous casting processes. Molten metal enters the casting mould (in [Figure 3210.02.01](#), the space between two rolls), solidifies there and leaves the mould as a continuous strip.

After casting the strip can be directly coiled – or it can be immediately (without down cooling) rolled into a coilable gauge. For the mass production of collapsible tubes and rigid cans the machines for the blanking of slugs or for extruding can be placed directly after the casting machines. In this way a continuous production is achieved.

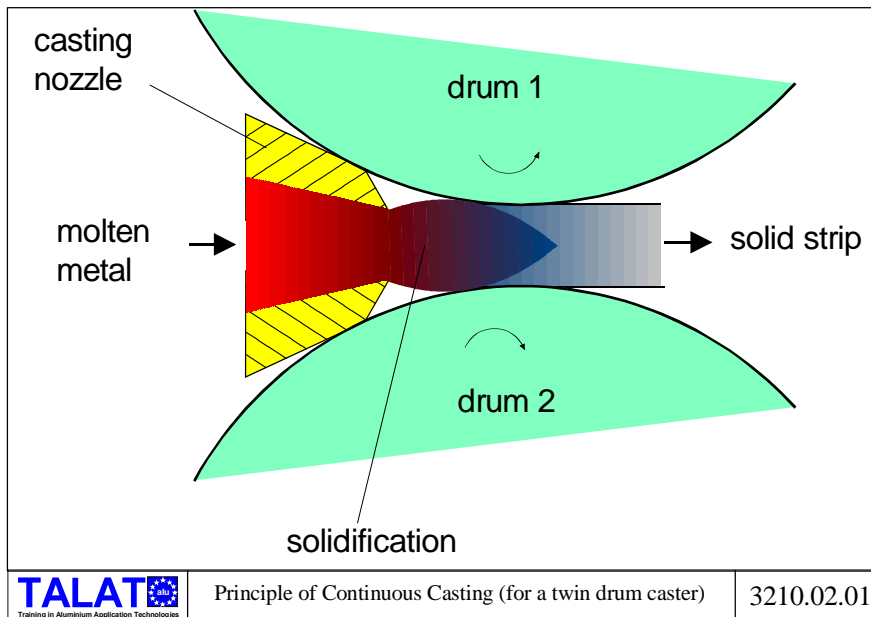

The conventional way of producing rolling slabs is DC (Direct Chill) semi-continuous casting although some slabs are produced by pouring molten metal into a permanent mould. After DC casting, the rolling slabs are re-heated to about 500°C and hot rolled to a coilable thickness between 4 mm and 6 mm.

The biggest advantage of the continuous technologies is the saving of several production steps in the production of strip or foil compared to conventional technologies.

Conventional technology:

Melting → DC-casting → hot rolling → coiling → cold rolling (possibly including several thermal treatments) → foil or canstock

Continuous technology:

Melting → strip casting → coiling → cold rolling (possibly including several thermal treatments) → foil or canstock

This saving of production stages includes several other advantages: compared with the conventional way, processing costs are only a third to a half as high, operating and investment costs are only a quarter to a third as high and there are smaller space and labour requirements. Less energy is required because it is no longer necessary to preheat the ingot before hot rolling. The productivity is 15-20% higher; the material consumption is 1.5 - 2% lower. Newer developments, such as those made by Pechiney and FATA Hunter, enable very thin strip to be produced (< 3 mm thick). This leads to even less rolling stages, e.g. when producing thin foil or beverage canstock.

When continuous casting was first introduced it appeared to have many advantages which result to production economies. However it soon became obvious that the technology introduced some features in the finished product that limited its use compared with conventionally produced material. Foilstock however in particular lends itself to the continuous strip route.

The most serious of these disadvantages is the difficulties that exist in casting alloys with high alloy content. Due to the wide freezing range of these alloys there is a danger of cracks in the strip. If not all the metal is solidified at the narrowest point of the casting machine, liquid or semisolid metal can leave the casting mould. It is possible to avoid this with a lower casting rate, but even this solution is limited because, if the casting rate is too low, it is possible to have solidification in the direction of the casting nozzle. In consequence, the casting rate of alloys is lower than that of commercially pure aluminium.

Therefore only alloys with a low alloy content can be cast, for example

- Commercially pure aluminium Al99.2 to Al 99.6 (series 1000);
- AlMn (max. 2% Mn, Series 3000);
- AlMg (max. 2 to 3% Mg, exception Alusuisse Caster II with max. 5% Mg, Series 5000),
- AlFe (max. 2% Fe) or
- AlMnFe (max. 1% Fe, max 1% Mn).

It is important to note that in any comparison of the output rate of different continuous casting processes, it is necessary to compare the production of the same alloys.

Usually the various strip casting technologies are divided according to the **dimensions of the finished product** into processes

- for wide strip casting (width up to 2150 mm),
- for narrow strip casting (maximum width 800 mm)
- for strip, that can be coiled immediately after casting (gauge max. 10 mm),
- for strip to be hot rolled after leaving the casting machine (gauge between 20 mm and 40 mm)
- for thin gauge casting (gauge under 3 mm)

Another distinguishing feature is the type of the caster (see chapter 3).

3210.03 Wire bar casting

The continuous casting of wire bars is also of great economic importance. As is the case for strip casting some production steps are saved. For the alloy content the same limitations obtain. That is why mainly commercial pure aluminium is cast. Other alloys eg AlMn and AlMgSi (Aldrey) are produced. All these materials are although used in electrical engineering.

3210.04 Distinguishing features of continuous casting technologies

The **continuous casting technologies** can be divided by processes into

- horizontal or
- vertical casting direction.

And by mould type

- fixed or
- mobile walls.

In the later case the walls are moving with the molten metal, while the walls are motionless in the former. Fixed walls are not used for industrial production and are not a topic of this lecture. Today five types of casters for continuous casting of aluminium are used. Most of them produce aluminium alloy slab or strip. The principle of operation is as follows:

1. The **twin drum caster**, which has considerable commercial application, especially for the production of foil stock, is shown in [Figure 3210.02.01](#) and [Figure 3210.04.01](#). It includes a source of molten metal which feeds into the space between a pair of counter-rotating, internally cooled drums (hollow rolls). In a very short time after leaving the casting nozzle the molten metal solidifies due to the contact with the water-cooled rolls. An homogeneous distribution of the melt must already occur in the casting nozzle. The casting direction can be horizontal or vertical (the later type used especially in earlier models). The solidification zone is 10 mm to 20 mm long and is followed immediately by a zone of hot-rolling in the same gap. All such methods are in fact roll casting processes because the strip thickness can be reduced of 5% to 20% in-situ by hot rolling. The strip usually has a temperature between 400°C and 550°C and can be directly coiled at hot temperature.

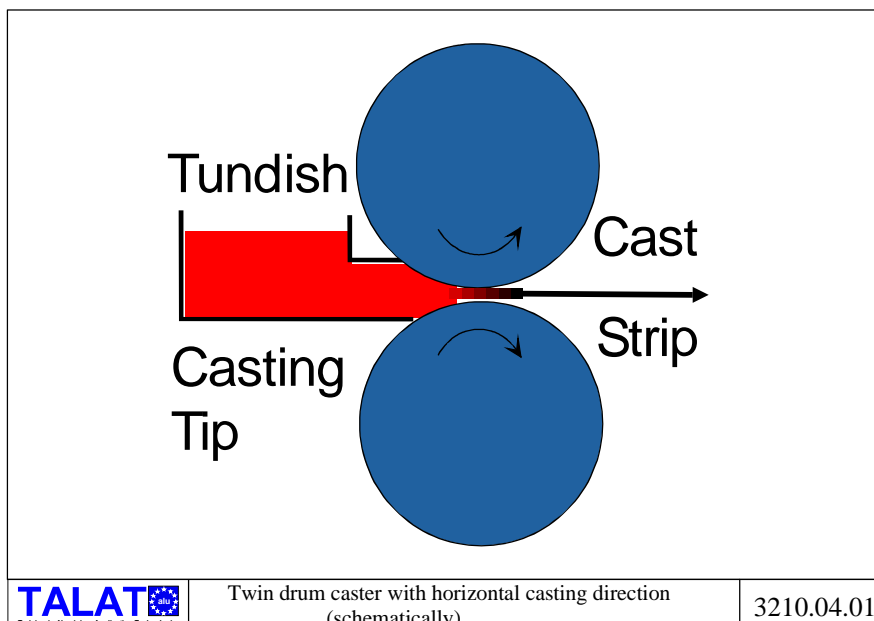

2. In **single drum casters** ([Figure 3210.04.02](#)), a supply of molten metal is delivered to the surface of a rotating drum that is internally water-cooled. The molten metal is dragged onto the surface of the drum to form a thin strip of metal, which cools on contact with the surface of the drum.

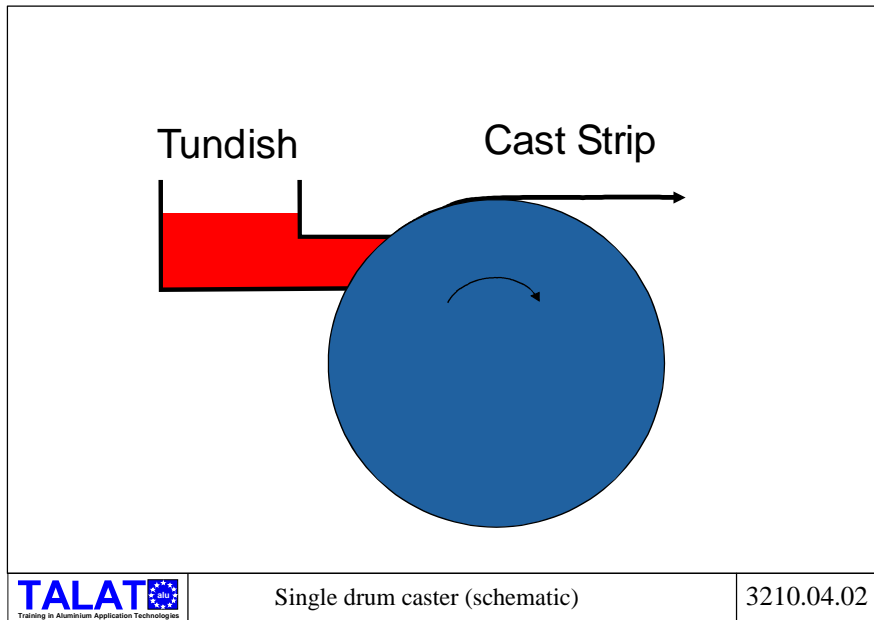

3. In **twin belt slab casting** equipment, two moving thin steel belts are provided which create a moving mould for the metal to be cast ([Figure 3210.04.03](#)). The belt is subjected to extremely high thermal gradients, with molten metal in contact with the belt on one side and a water coolant in contact with the belt on the other side.

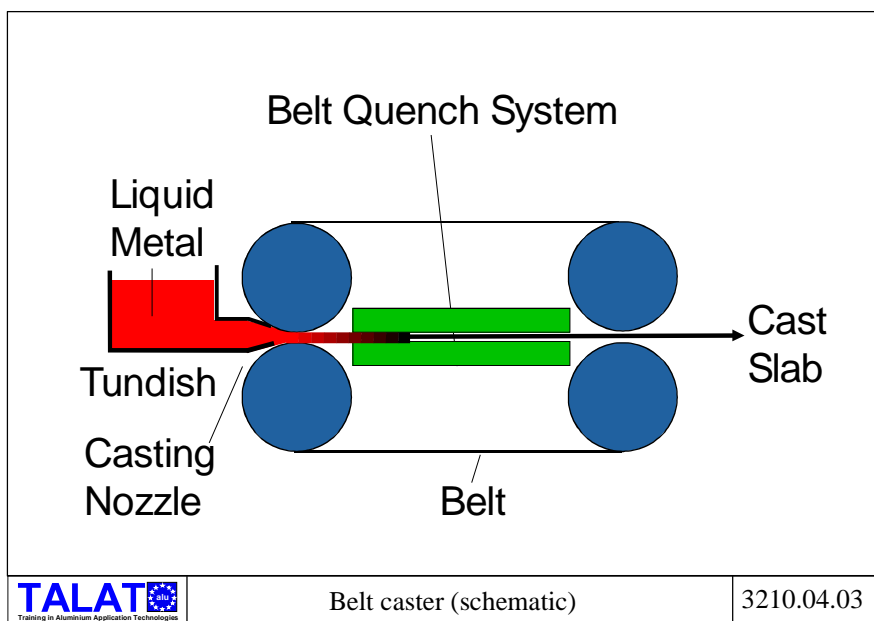

4. The **block caster technique** is illustrated in [Figure 3210.04.04](#). A number of chilling blocks is mounted adjacent to each other on a pair of opposing tracks. Block casters require precise dimensional control to prevent flash (transverse metal fins) caused by small gaps between the blocks. Such flash can cause sliver defects when the strip is hot rolled.

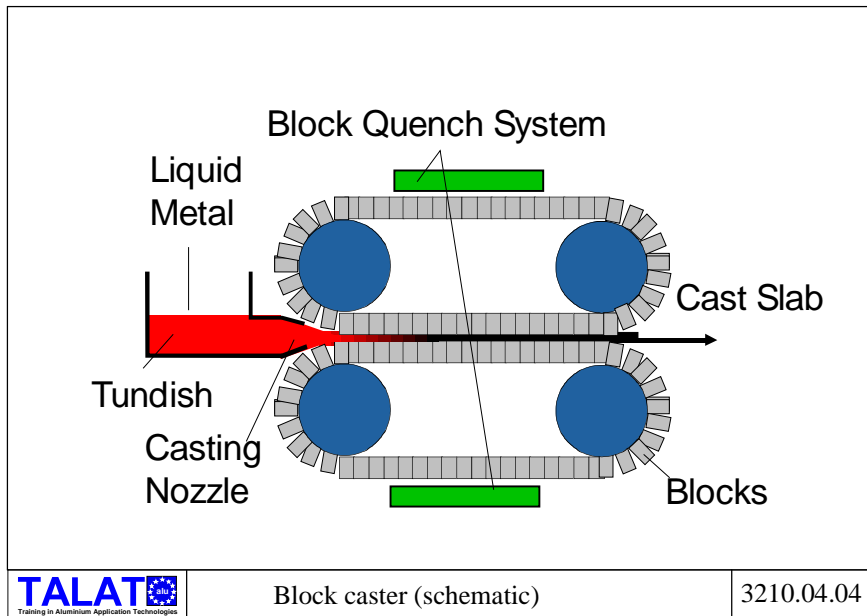

5. A **combination of a rotating steel belt and a water-cooled casting wheel**. Here the mould is formed between the belt and a sector on the outside of the casting wheel (see [Figure 3210.04.05](#)).

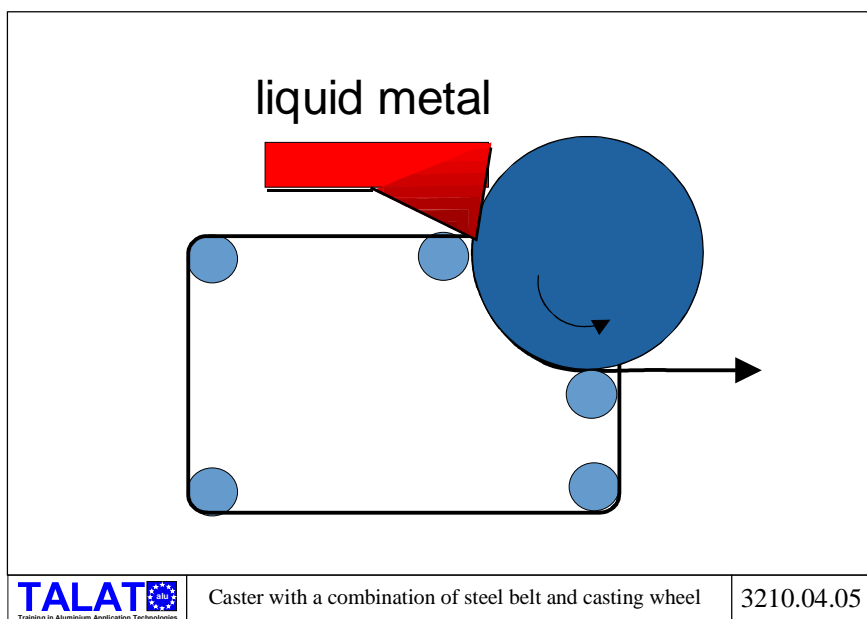

There follows a description of some of the casters used for commercial production of aluminium slab or strip.

3210.05 Twin drum casters

Several twin drum casters have been developed which produce coilable gauges (below 10 mm).

3210.05.01 Vertical casting direction

a) Vertical downward - Hazelett Sr. (1930 – 1940)

The first patent for strip casting of steel by Bessemer is dated in the year 1848. For aluminium the most important technologies for continuous strip casting were developed by J. Hunter (Hunter-Douglas, Hunter Engineering), W. Lauener (Alusuisse Casters I and II) and W. Hazelett. Hazelett Sr. constructed the first machine for the industrial casting of aluminium strip in the late thirties. It was a twin drum caster with vertical casting direction (see [Figure 3210.05.01](#)). The molten metal was cast from the top into the space between two casting rolls. The strip leaves vertically downward between the rolls. The machine was used for the casting of narrow strip for the Crown Cork Company (USA).

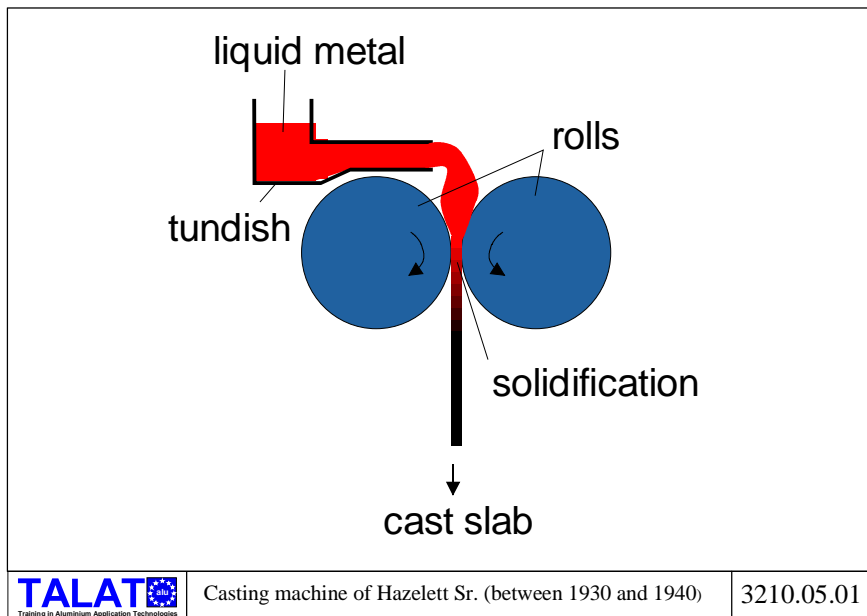

b) Vertical upward - Hunter Engineering

Since 1948 the Hunter Engineering machine has become more and more important; the molten metal is fed vertically too, but with one difference: The metal flow is upward

(see [Figure 3210.05.02](#)). The casting nozzle is situated beneath the two rolls. By the metallostatic pressure, determined from the level of liquid in the tundish, the molten metal flows through the nozzle and immediately into contact with the rolls. The rolls transport the solidified material in such a way, that the material gets a light deformation. The strip leaves at the top and it is being coiled.

The magnesium content is limited to 2.0%. The temperature of the finished strip is 300°C to 350°C. It is possible to cast strip up to 1700 mm width with 6 mm to 9 mm gauge.

A Russian technology is working with the same casting direction.

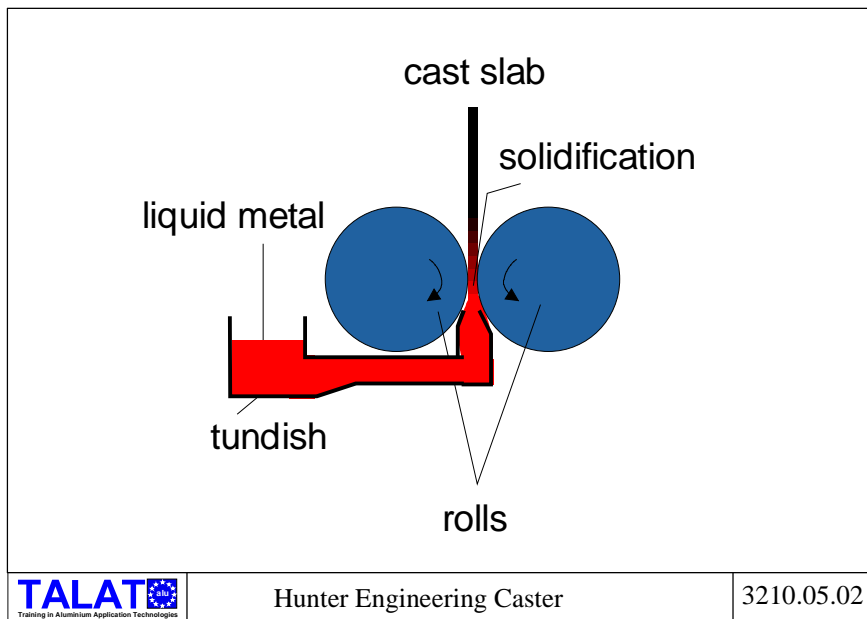

3210.05.02 Casters with horizontal casting direction

Today casters with horizontal feeding are of great importance for the production of wide aluminium strip between 1000 mm and 2000 mm width and a gauge between 6 mm to 10 mm, in the latest developments even 2 mm to 3 mm (thin roll casters).

a) Scal, Alusuisse I, Jumbo 3C

Examples of this construction are the Alusuisse I, and Jumbo 3C (Pechiney, Scal 3C) casters. The casting rate usually depends on the alloy, between 1 (0.8) m/min to 5 m/min (for example typically 1 m/min at 6 mm gauge for Alusuisse I). Well over 100 of casters with horizontal casting direction are installed worldwide. [Figure 3210.05.03](#) shows the typical construction.

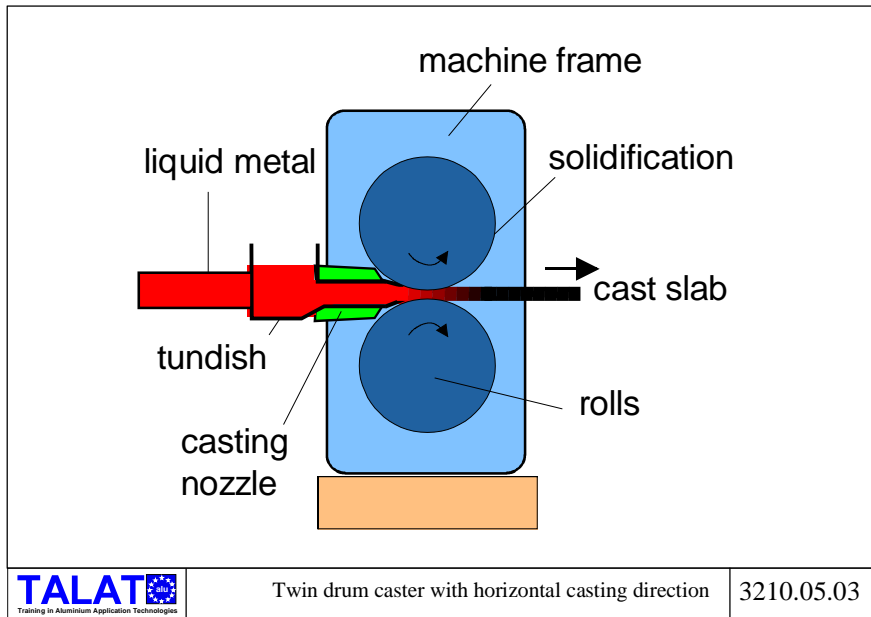

The cast strip emerges horizontally from the caster and is directly wound into coils while hot (**Figure 3210.05.04**). The coil size is adapted to the following cold rolling mill.

These machines are the most suitable for alloys with a short range of solidification, for example the 1000, 3000 and 5000 series (with up to 2.5% Mg content). They can be used when liquid metal is emerging directly from a smelter or when a good quality of scrap is to be recycled. However, for casting higher alloy contents, the casting rate must be significantly reduced, leading to an uneconomic productivity.

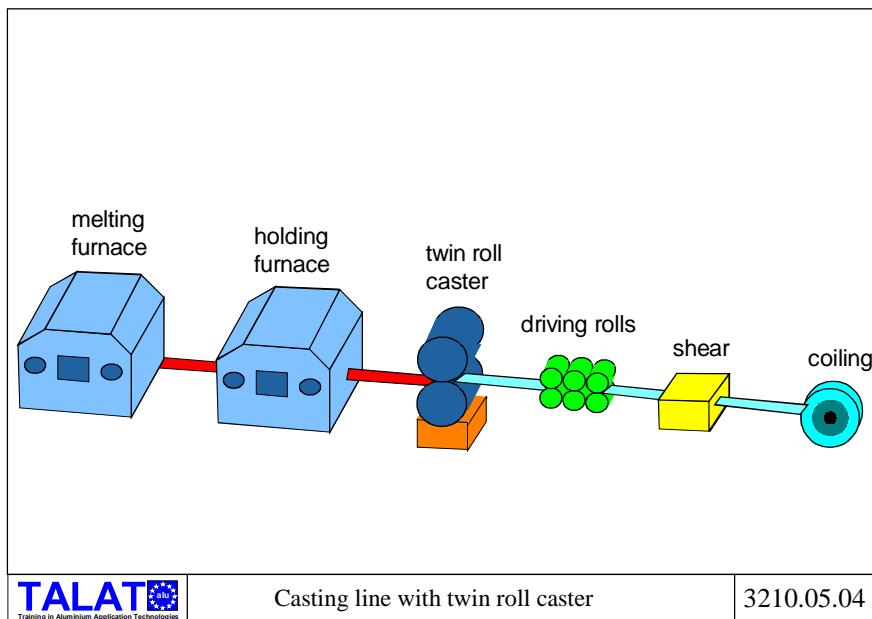

b) The development of the Jumbo 3C to the Jumbo 3CM thin roll caster

The 3C (standard caster) was developed by Pechiney (France) in 1959 and produced 1500 mm wide strip in 6 mm gauge in 1959. The liquid metal was solidified between the cooled rolls of a 2-HI rolling mill with a roll diameter of 620 mm.

The next generation of casters, known as Jumbo 3C, is capable for casting 2150 mm wide strips. The roll diameter was increased to 960 mm resulting in an increase in productivity.

In both cases these casters show several metallurgical advantages due to the rapid solidification – less than 3 seconds for a strip of 10 mm thickness.

The Pechiney caster has been further developed into a machine that can cast strip in very thin gauges with an improved surface quality– the thin roll caster, Jumbo 3CM (1997, [Figure 3210.05.05](#)). This development had the following background: In the past caster manufacturers had developed equipment and processes to reduce the as-cast gauge from the 6 - 10 mm range down to 3 - 5 mm. Even so, the desired gauge is typically only 2 mm or less. With an as-cast strip gauge of 1 mm or less, it would offer the potential for even higher productivity and greater cost reductions.

The new caster features all the state-of-art equipment for roll casting including a new mechanical tip positioner and a new roll cooling system. The casting program covers a number of alloys, 1000, 3000 and 5000 series, at gauges between 2 and 3 mm.

An optimum thickness below 3 mm (determined experimentally at around 2 mm) permits the following benefits: metallurgical advantages of rapid speed of solidification (see [section 3210.10](#)), strip geometry compatible with high speed cold rolling requirements, reasonably sized caster. To use the full benefit of these advantages the shape and size of the nozzle were entirely redesigned to ensure a regular, turbulence-free molten metal supply.



TALAT
Training in Aluminium Application Technologies

The Jumbo 3CM caster at Neuf Brisach
(Pechiney Aluminium Engineering, France)

3210.05.05

The new developed Jumbo 3CM casting line features a tilting melting/holding furnace, a molten metal feed system including a motorised support table, a tundish and a previously set-up nozzle kit and an automatic level control system in the tundish and nozzle. For some alloys, the last parameter plays an important role because of its influence on the heat exchange between the molten metal and the rolls, which effects on the structure of the skin of the product.

Some other features of the caster are a 2-Hi mill with internally cooled, 1150 mm diameter rolls, a purpose-designed roll lubrication system and an edge trimming shear. The strip thickness ranges from 1 mm to 10 mm, the width up to 2020 mm. The strip is suitable for foil production in thicknesses down to 6.5 μm . Thanks to the very fine grain structure due to the rapid solidification, the final foil quality is excellent.

c) Casting direction at an angle - The FATA Hunter SpeedCaster

Another and one of the most popular concept, is the Fata-Hunter Caster with its main feature of the unique 15° tilt back stand. This allows the molten metal to flow into the caster in a smooth and non-turbulent manner (Figure 3210.05.06). The large diameter-to-width ratio caster rolls maintain very close strip profile tolerances.

The latest development is the Fata-Hunter SpeedCaster (1997, figures 12b and 13) that was developed to meet the demand for lighter gauges and increased productivity.

The SpeedCaster bases on the twin roll casting process, which was developed by Joseph Hunter in the 1950's. The early machines (known as Hunter "standard" casters) were limited in casting width and alloy composition. In the late 1970's Hunter introduced a much more robust machine ("SuperCaster") which offered an increase in productivity and was capable of casting a wider range of alloys at sheet widths up to 2.0 m.

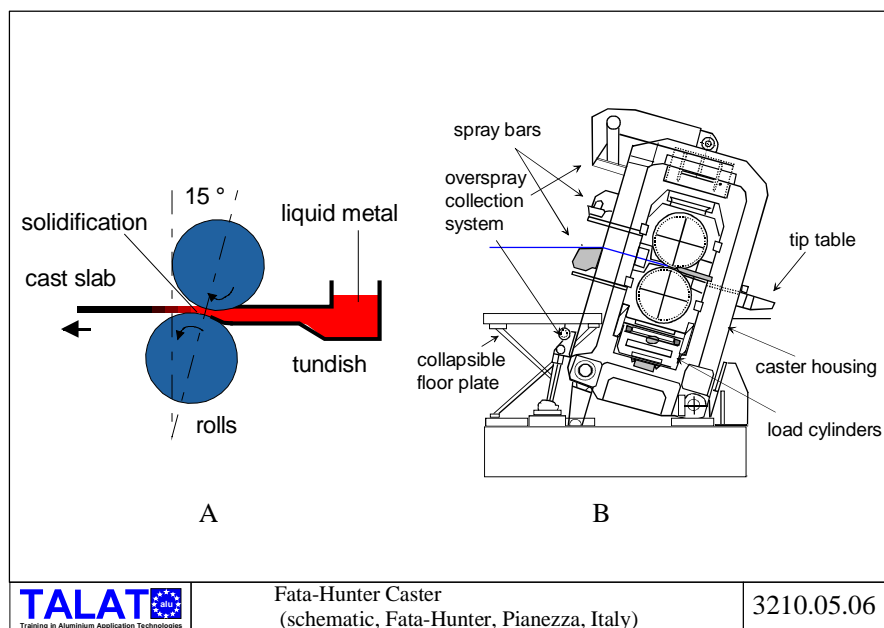

The SpeedCaster (**Figure 3210.05.07**), a 2-Hi Thin-Gauge/High-Speed casting machine is 2184 mm wide and can produce a trimmed cast strip width of 2134 mm. The machine is rated to run at speeds as high as 38.1 m/min and at gauges as low as 0.635 mm.

The development of Thin-Gauge/High-Speed casting technology could be utilised to produce foil products in a cost-effective manner. It is suited for an aluminium Mini-Mill plant. The process is supplying thin-gauge material directly to an intermediate foil mill, followed by a finishing foil mill. The cost of the proposed Mini-Mill is significantly lower than a SuperCaster based plant because an expensive breakdown cold rolling mill is not required.



3210.06 Single drum casters

Continuous drag casting (**Figure 3210.06.01**) utilises a single wheel design to make aluminium strip. In the past years, this method faced many difficulties and the technology has not been openly introduced to industry. However, recent developments have made the process more consistent and more suitable as a replacement for other processes for certain product lines. It can be an alternative method for low cost production of thin-gauge aluminium strip, but the technology is still in the prototype stage.

A prototype caster, developed by Reynolds Metals (1997), identifies drag casting as a high productivity and low capital cost process. A unique feature of the process is the very high cooling rate; it has advantages when the desired range is 2 mm or less. It can indeed produce thickness as low as 1.0 mm thus reducing the number of rolling passes to reach final gauge.

The most important part of the melt drag technology is a single casting wheel which is composed of an inner core, containing cooling channels, and a grooved exterior shell

(Figure 3210.06.01). Molten metal is introduced to the wheel via an open tundish and is instantly cooled. As the wheel rotates, solidification continues at the liquid /solid interface and typically ends one to two inches outside of the molten pool. Thus, solidification is virtually unidirectional. Because the top surface of the sheet is unrestricted, uniform cooling must be closely maintained across the wheel to avoid gauge variations. The typical rate for melt drag casting is between 50 m/min and 70 m/min. For the most alloys this speed range results in a gauge range of 1 mm to 1.3 mm.

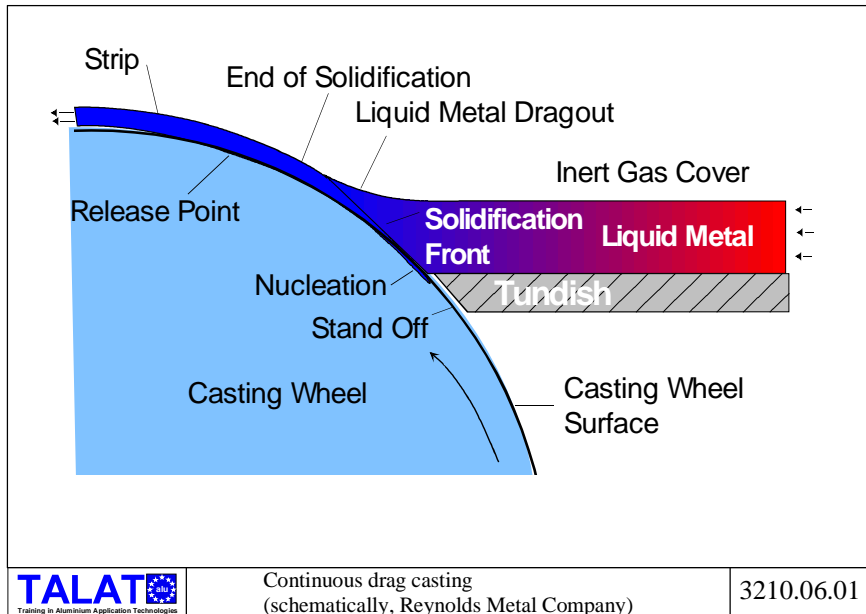

3210.07 Block casters

Block casters are shown schematically in Figure 3210.04.04. Two types are in operation, which have the same construction principle. Differences are given in the type of cooling. Therefore materials with various alloy contents can be cast. The strip usually has gauges over 16 mm and must be hot rolled immediately after casting. That's why block casters have at least two hot rolling stands in tandem with the casting machine.

3210.07.01 Hunter-Douglas (Block caster)

In the USA Joe Hunter at first developed the Hunter-Douglas-Process, that worked with chains of rigid steel moulds with internal water-cooling. These mould blocks are rotating like caterpillar tracks and cooled with water from the inside. This machine is limited to casting widths under 610 mm. The gauges are at about 16 mm, the casting rate at 2 m/min to 4 m/min. The magnesium content is limited to a maximum of 3.5%. For attaining a good surface quality it was very important, to adjust all single rigid moulds in an accurate way. But the surface quality was limited due to the high thermal stresses in the mould blocks, caused by the unidirectional heat flow. That means that the

heat passed directly from the solidifying metal through the steel block into the cooling water. The resulting thermal stresses gave rise to fatigue cracking at the surface of the mould blocks – thus the surface quality of the strip was limited. In 1970 a new construction was developed, in which the steel blocks absorb the heat of solidification. In this case the heat is given up to the cooling water only after the blocks have lost contact with the solidified strip and during their return to the next contact with the molten metal.

3210.07.02 Alusuisse Caster II

This caster (construction W. Lauener) is producing slabs and strips up to 1750 mm width with gauges between 10 mm and 40 mm and a casting rate from 0,5 m/min to 10 m/min. The technology is suited for a wider range of alloys, for example for aluminium with up to 5% magnesium. It is used for casting canstock (Al-Mg-alloys) and for recycling used beverage cans (UBC). The machine can be used for casting materials that are likely to suffer chill cracks in the case of fast cooling. It is possible to cast strip or slab. The annual capacity for such casters can reach 100 kt/year with three-shift operation.

The caster has two sets of blocks, which rotate to form a moving mould cavity into which the liquid metal is poured. Due to the contact with the chilling blocks the metal solidifies. The strip is transported together with these blocks until it is cool enough to leave the caster. Then the blocks lift off and return. On their way back the heat absorbed by the blocks is removed by external cooling.

This cooling section with its unique construction is the reason of the ability to produce a wider range of alloys. The heat flow in the moulds is reversed. Block temperatures between 50°C and 200°C can be used. It is possible to control the casting process on several ways: the solidification rate by cooling, the casting rate, the surfaces of the moulds and coating of the moulds.

3210.08 Belt casting techniques

Another way is to solidify the molten metal between two rotating steel belts. Examples for this type of casters are the newer Hazelett caster and the Kaiser caster (see scheme in [Figure 3210.04.03](#) and [Figure 3210.08.01](#)).

3210.08.01 Hazelett Caster

In the Hazelett Caster (see [Figure 1301.02.06](#)) the melt solidifies between two rotating thin steel belts (about 1.5 mm thickness) which are cooled during the contact with the melt. With this technology slabs are produced from 15 mm to 25 mm thickness and up to 2000 mm width. The machines are used for long lengths of plate and strip up to 1750 mm wide (bus bars, stock for sheet, foil and cans).



The process is shown schematically in [Figure 3210.04.03](#). [Figure 1301.02.06](#) shows the casting machine. The principle of operation is to pour the molten metal into the space between the belts via a casting nozzle, with the same width as the strip to be cast. In this space between the belts the metal solidifies and is drawn out of the machine by a pinch roll. The casting rate is 5 m/min to 9 m/min.

After leaving the machine at a temperature of 420°C to 460°C the strip is immediately (in line) hot-rolled down to a coilable gauge between 2 mm to 6 mm. Thus this caster has – like block casters - at least two hot rolling stands in tandem with the casting machine. This strip is coiled with a temperature of about 200°C.

The alloy range is wider than in the case of twin drum casters with a limit for the Magnesium content at 3%. But the best results are obtained with pure aluminium and AlMn alloys. The product is not suitable for applications desiring extra high surface quality.

3210.08.02 Kaiser Caster

In both cases – block and belt techniques - the surface quality was not sufficient for the production of foilstock. That's why the new Kaiser Caster was developed, which is part of the companies Micromill concept.

This concept is based on a continuous can stock substrate processing line composed of: Molten metal holding furnaces, metal degassing and filtration, “Kaiser Caster”, hot

rolling stands, annealing and quenching, cold rolling stands and coiling. For example the line is capable of producing three beverage can substrate products: body, lid and tab. The process offers many advantages over conventional rolling mills, for example major reductions in process time and capital requirements - while maintaining high quality (see [Figure 3210.08.01](#)). Kaiser Aluminium wholly owns the design, but the carriage assembly was designed in a joint development between Kaiser and Hazelett Strip Casting Corporation in 1997.

The thickness of the strip to be cast is related to the thickness of the belts, the return temperature of the casting belts, and the exit temperature of the strip and belts. In addition, the thickness of the strip depends also on the metal being cast. The absence of water cooling on the back side of the belt while the belt is in contact with hot metal in the moulding zone significantly reduces thermal gradients and eliminates problems of film boiling occurring in the casting zone when the critical heat flux is exceeded. This design also minimises cold framing, a condition where cold belt sections exist in three locations: before metal entry and on each of the two sides of the mould zone of the belt. Cold framing can cause severe belt distortion. Another feature is the easy starting: A quality product is available within 15 minutes. Other advantages are a product release from sticking occurs without problems and a high production rate. The product temperature is sufficiently elevated for in-line hot rolling.

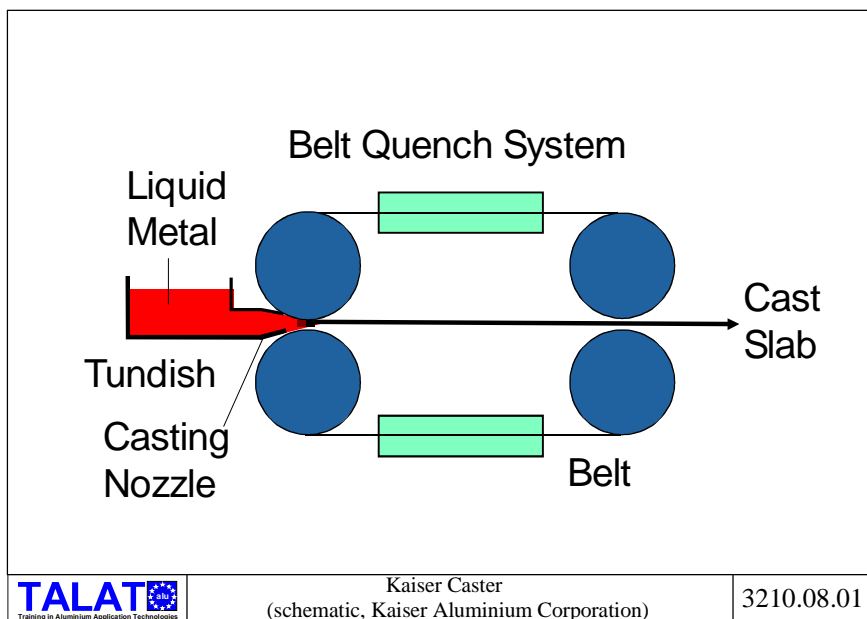

3210.09 Casters with a combination of a rotating steel belt and a water-cooled casting wheel

In this casters the mould is formed between the belt and a groove on the outside of the casting wheel (see [Figure 3210.09.01](#)). It is possible to cast strip or wire-bar with this construction.

3210.09.01 Properzi-Caster

The Properzi-Caster (invented by Ilario Properzi, Italy, 1950, [Figure 3210.09.01](#)) has a great importance for industrial production of wire bar from aluminium (or copper) for electrical engineering. The usual alloys are electrical conductors grades, for example commercially pure aluminium 1350, alloys of the 3000 series and 6101(AlMg1SiCu), Aldrey (AlMgSi Type).

The principle of operation is schematised in [Figure 3210.09.01](#). The mould is formed between the grooved periphery of the rod casting wheel and the endless steel belt. The casting wheel is water-cooled. The molten metal solidifies between the belt and the casting wheel, whose diameter can be up to 2600 mm. The cast bar has a triangular or trapezoidal cross section (up to 3120 mm²) and a temperature of about 350°C after leaving the casting wheel. It is immediately hot rolled down to coilable wire stock. The cast, shaped strands are usually rolled and drawn to wire, and then coiled.

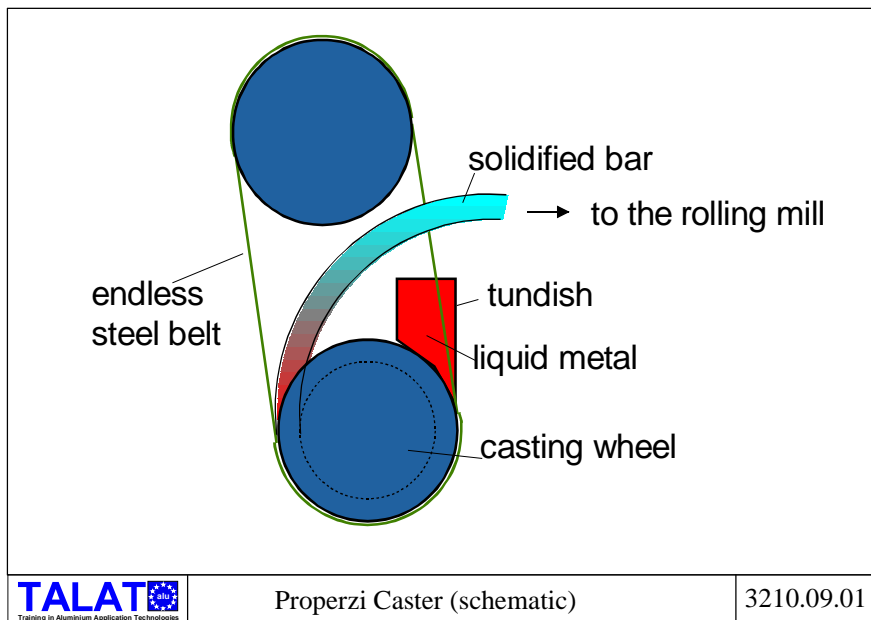

Properzi rod is usually delivered at 12 mm diameter to be drawn by dry drawing machines to a final diameter of 0.3 mm to 4.0 mm depending on the application.

3210.09.02 The Rigamonti and the Rotary Caster

The Rigamonti machine ([Figure 3210.05.05](#)), which is similar to the Properzi machine, uses a wheel and an endless belt to form the mould, into which molten metal is poured. It can be used to produce cast strip up to 200 mm wide. The casting speed is 14 m/min (e.g. can stock).

The rotary strip casting (RSC) machine ([Figure 3210.09.02](#)) is a further development of the original Rigamonti machine. By adding a further guide roll, the cast strip leaves the unit in a horizontal direction without any transverse deviation. It is used to produce strip up to 500 x 20 mm cross-section. These narrow strip casters are mostly used for the production of small discs (“slugs”), used for the impact extrusion to aerosol containers, cans and tubes. Other applications are sidings and evaporators for refrigerators.

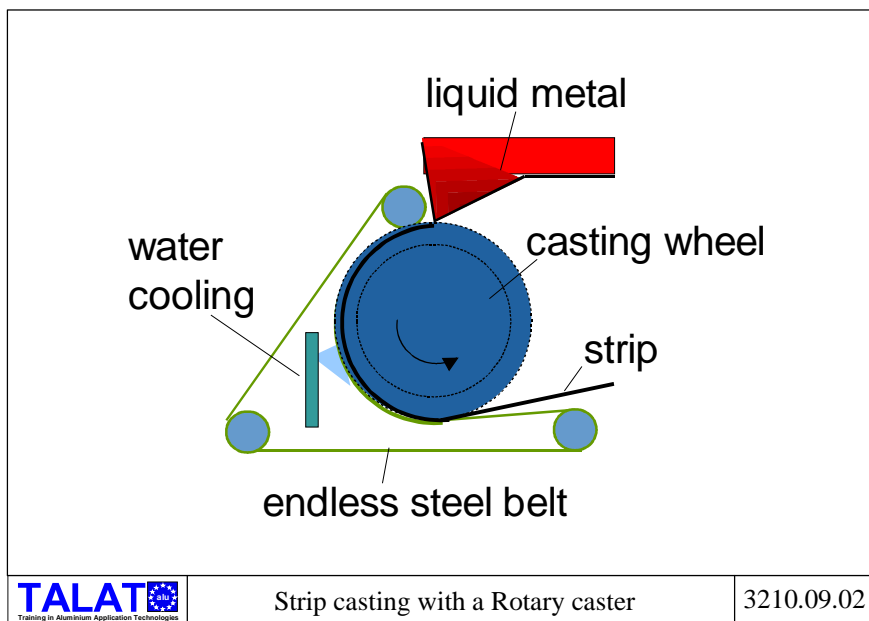

3210.10 Structure and properties of strip castings

Main features of all continuous casting technologies are a high solidification and cooling rate, which affect the structure compared to conventional products (DC casting followed by hot and cold rolling). In particular, the very much higher solidification rates (see Table 1) have an effect, as does the formation of two or more solidification fronts. For example the dendrite spacing and cell sizes are decreasing with higher cooling rate (see TALAT [Lecture 1254](#)).

Table 1: Comparison of some casting processes (all values are average values for commercially pure aluminium)

Casting process	Cooling rate in K/s	Dendrite arm spacing in μm	Cell size in μm	Comment
mould casting	0,01 – 0,1	100		Depending on type and temperature of mould
DC casting	0,5 - 20	12 - 15	50 - 90	
Properzi	0,5 - 13	8		
Die casting	20 - 80	5		
Strip casting	200 - 700	1 - 2		
- twin drum casters	e.g. 450 K/s for Hunter Engineering process		5 – 25	
- block and belt casters			40 – 80	
- Continuous drag casting	≈ 6000			

Continuous cast products show a supersaturation of alloying elements or impurities, that can have an effect on subsequent thermal treatments. Other features are a higher density of imperfections (especially dislocations, dislocation loops, vacancies and vacancy clusters), a fine grain size, surface segregation and a centreline segregation.

Table 1 shows that there are differences in the cooling rate for the special continuous caster types. For this reason the products of different casters can have a variety of structures and properties. But nevertheless, some main features of all these strip castings can be summarised – the grain size and the supersaturation.

Other differences are created by different holding times at higher temperatures, which can lead to a reduction of the supersaturation and to grain coarsening. Therefore not all of the aforementioned features are to be found to the same degree in every continuous casting.

In consequence, depending on the process, continuous castings show differences in structure and properties. Some examples:

- **Twin roll casters** show several metallurgical advantages due to the rapid solidification – for example in Pechiney casters less than 3 seconds for a strip of 10 mm thickness. A fine cast structure is obtained with fine dendrites and a fine grain size. Segregation is lessened. Therefore some alloys could have better properties than conventional produced foilstock. After the casting the material has to be cold rolled, where a high degree of deformation brings a good quality of the surface. Between the rolls strip has a light plastic deformation.

- Due to its very high cooling rate, continuous drag casting (**single drum caster**) allows unique alloy modifications that yield improvements in physical properties. The solidification is virtually unidirectional; a phenomenon that has both advantages and disadvantages. On the positive side, solidification conditions produce a very unique microstructure, eliminates alloy segregation, and produces smaller intermetallic particles than conventionally processed material. These characteristics provide unique opportunities to achieve specific mechanical and physical properties through simple alloy modifications. On the other hand, possible irregular solidification can lead to unwanted inhomogeneous structure.
- The strip of **block and belt casters** mostly can not match the quality of conventional hot-rolled strip, because its surface is streaky. Compared to twin drum casters the strip has a lower supersaturation with the elements manganese, iron and silicon.

3210.11 Behaviour of strip castings in further processing (rolling, thermal treatment)

In further processing the special features of the material must be taken into account. Due to the fast solidification rate the strip can show a significant supersaturation, that influences all processes of rolling and the thermal treatment.

3210.11.01 Cold rolling

Strip casting shows essentially the same behaviour as conventional strip under a cold deformation, as shown in **Figure 3210.11.01**, **Figure 3210.11.02** and **Figure 3210.11.03** (for materials from twin roll casters). With an increasing degree of cold work the tensile strength is increasing, while the elongation is decreasing.

For commercially pure aluminium the values for tensile strength and elongation are approximately the same, with a little difference in the values for the elongation under 20% degree of deformation.

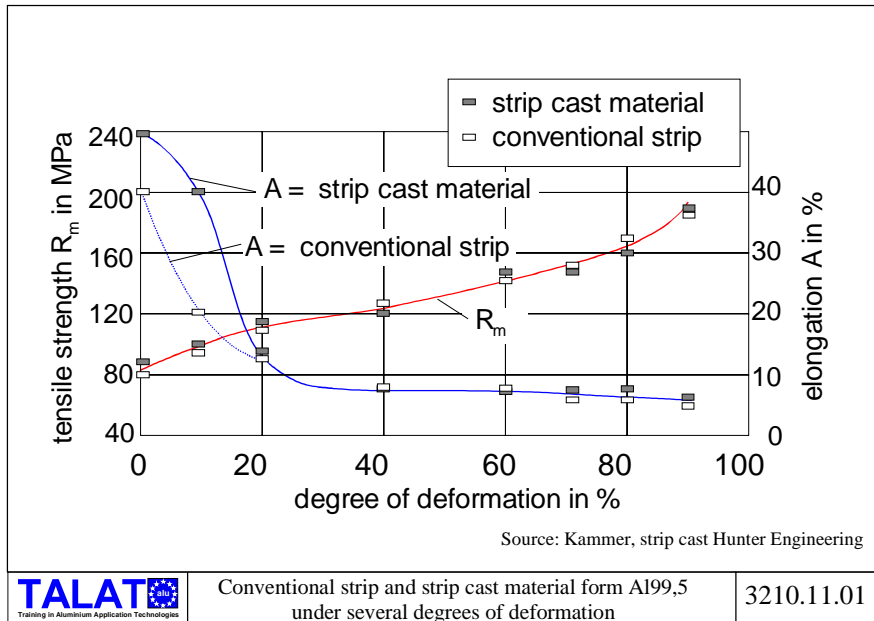

In the case of alloys (Figure 3210.11.02 and Figure 3210.11.03) the differences between strip cast and conventional strip are more distinct. All values for the tensile strength are 20% to 50% higher than in the conventional material. The reason for this behaviour is to be seen in the higher supersaturation of the strip cast material due to its higher solidification rate.

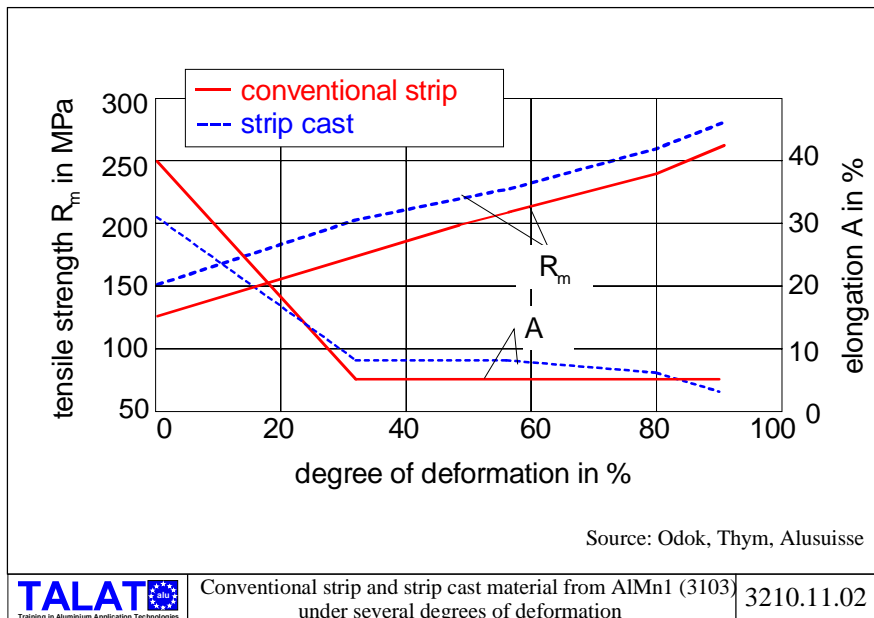

If the alloy content is at about 2% (AlFe2, AlMn1Fe1, see Figure 3210.11.03) the ductility can raise with increasing degree of deformation. The reason for this phenomenon is to be seen in the primary precipitations, that build a dense net in the as-cast condition. Above 40% degree of deformation this net is broken and the deformation

becomes more homogeneous resulting in an increase in ductility.

If the strip cast is homogenised (an annealing at higher temperatures) before cold rolling it shows a similar behaviour like conventional material due to the reduction of the segregation.

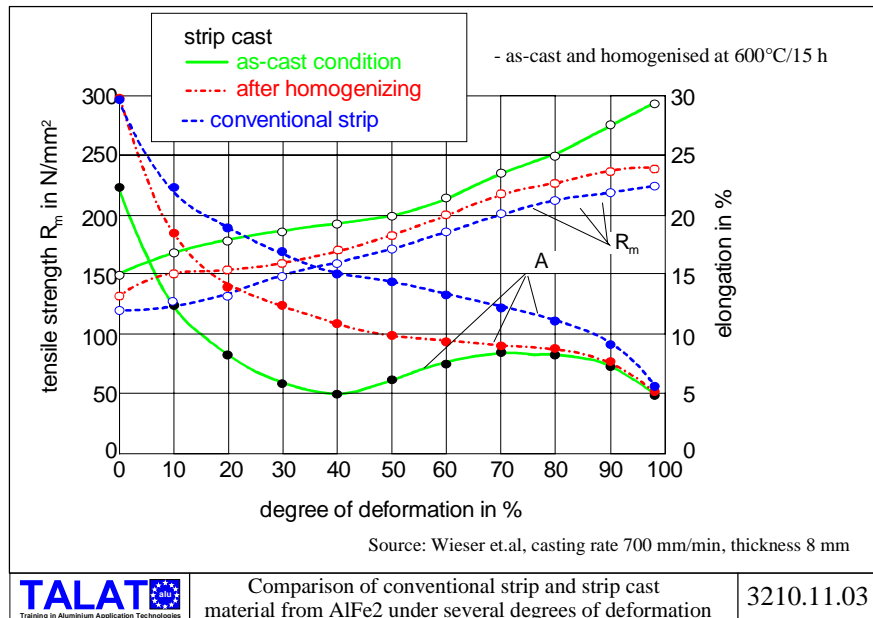

3210.11.02 Deep drawing

Compared to conventional material strip cast is sometimes not ideal for deep-drawing or other operations requiring extensive forming, for example bending over a small radius. The reason for this is to be seen in the relatively slight deformation between the rolls – depending on the strip casting process. Also, when the material is cold rolled from 9 mm to 1 mm the resulting deformation is very lower compared to a conventional material after hot and cold rolling. Therefore strip cast can show the “orange peel” effect after deep drawing, caused by the cast grains that form a surface texture.

3210.11.03 Recrystallization

Figure 3210.11.04 is showing the recrystallization behaviour of commercially pure aluminium A199,5 (1050A) produced by three routes. All materials show the same type of curve including recovery, recrystallization and grain coarsening. The values for the as-cast strip are higher than those of the other materials because of the higher supersaturation that delays the recrystallization processes. With an annealing at higher temperatures (homogenisation) before cold rolling the supersaturation can be reduced. Therefore this material shows a curve that is more similar to the conventional material.

With increasing alloy content the effect of a delayed recrystallization becomes more and more significant. As shown by a comparison between Al99,5 and AlMn1Fe1-strip casting material the range of recrystallization becomes more flat (Figure 3210.11.05).

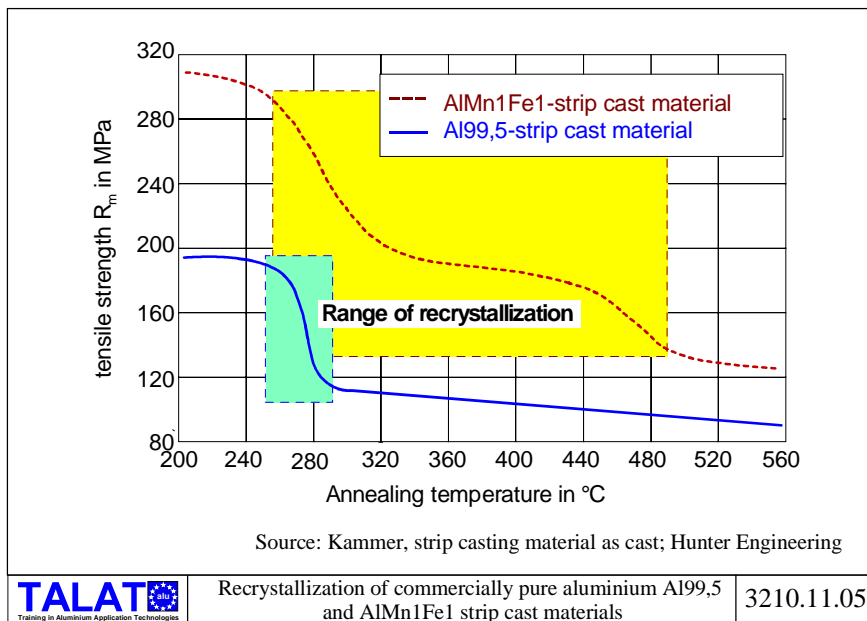
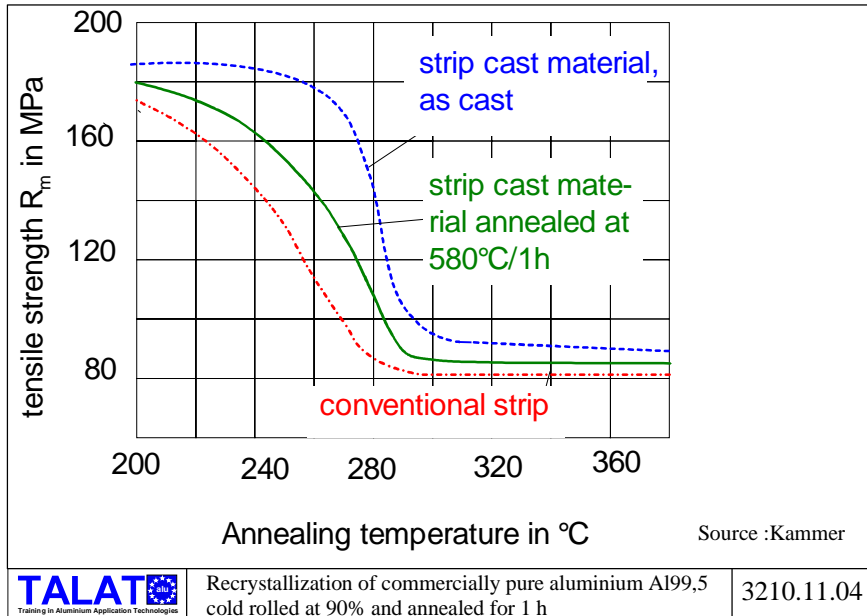

3210.12 Literature

1. Altenpohl, D. G.: Aluminum: Technology, Applications and environment. TMS and Aluminum Association 1998
2. Development of thin gauge/high-speed roll casting technology for foil production. Aluminium 74(1998)10, p. 750/753
3. Kammer, C., et.al.: Thermomechanical treatment of Al99,5 strip casting (in german) Neue Hütte 35(1990)11, p 418/421
4. Kammer, C., Krumnacker, M.: Precipitations in AlMn1Fe1-strip casting (in german), Aluminium 68(1992)1, p. 60/63
5. Kammer, C., Krumnacker, M.: Thermomechanical treatment of AlMn1Fe1-strip casting (in german) Metall 43(1993)12, p. 1162/1168
6. Kammer, C.: Aluminium-Taschenbuch, Vol. 1, Aluminium-Verlag Düsseldorf 1998
7. Latest technical developments in continuous casting. Report about Alumitec'97, Atlanta, Aluminium 73(1997)10, p. 685/689
8. Odok, A., Thym, G.: Advantages and disadvantages of continuous strip casting processes. Aluminium (in german), Aluminium 50(1974)7, p. 454/456
9. Odok, A., Thym, G.: Continuous strip casting technologies for aluminium. Aluminium (in german), Aluminium 50(1974)6, p. 411/414
10. Pechiney reports on success of its Jumbo 3CM machines. Aluminium 74(1998)5, p. 316/317
11. Wieser, D., et.al.: Influence of the solidification conditions on the properties of Al-Fe strip cast (in german), Metall 40(1986)6, p. 584/591
12. Szczypiorski, W., The evolution and Importance of Hazelett Caster Belt Coatings, Conference on Aluminium Cast House Technology: Theory & Practice, Melbourne, Victoria, Australia, 4-8 July 1993, The Minerals, Metals & Materials Society, USA, 1993
13. Regan, P.C., Recent Advances in Aluminium Strip Casting and Continuous Rolling Technology – Implication for Aluminium Can Body Sheet Production, Light Metal Age, 50, (1-2), , 1992, p.58-61
14. Regan, P.C., The Hazelett Twin-Belt Aluminium Strip-Casting Process Caster Design and Current Production Program for Aluminium Alloy Sheet, Conference on Science and Engineering of Light Metals RASELM '91, Tokyo, Oct 1991, p. 1059-1064, Japan Institute of Light Metals, 1991

3210.13 List of Figures

Reference	Content
3210.02.01	Continuous casting in principal (in this example for a twin drum caster)
3210.04.01	Twin drum caster with horizontal casting direction (schematically)
3210.04.02	Single drum caster (schematic)
3210.04.03	Belt caster (schematic)
3210.04.04	Block caster (schematic)
3210.04.05	Caster with a combination of steel belt and casting wheel
3210.05.01	Casting machine of Hazelett Sr. (between 1930 and 1940)
3210.05.02	Hunter Engineering Caster
3210.05.03	Twin drum caster with horizontal casting direction
3210.05.04	Casting line with twin roll caster
3210.05.05	The Jumbo 3CM caster at Neuf Brisach (Pechiney Aluminium Engineering, France)
3210.05.06	Fata-Hunter Caster (schematic, Fata-Hunter, Pianezza, Italy)
3210.05.07	Fata-Hunter Speedcaster (Fata-Hunter, Pianezza, Italy)
3210.06.01	Continuous drag casting (schematically, Reynolds Metal Company)
1301.02.06	Hazelett Twin Belt Slab Caster
3210.08.01	Kaiser Caster (schematic, Kaiser Aluminium Corporation)
3210.09.01	Properzi Caster (schematic)
3210.09.02	Strip casting with a Rotary caster
3210.11.01	Conventional strip and strip cast material form Al99,5 (1050 A) under several degrees of deformation (Kammer, strip cast Hunter Engineering)
3210.11.02	Comparison of conventional strip and strip cast material from AlMn1 (3103) under several degrees of deformation (Odok, Thym, Alusuisse Caster I)
3210.11.03	Comparison of conventional strip and strip cast (as-cast and homogenised at 600°C/15 h) material from AlFe2 under several degrees of deformation (Wieser et.al, strip casting comparable to twin roll caster material, casting rate 700 mm/min, thickness 8 mm)
3210.11.04	Recrystallization of commercially pure aluminium Al99,5 (1050A), cold rolled at 90% and annealed for 1 h (Kammer)
3210.11.05	Recrystallization of commercially pure aluminium Al99,5 (1050A) and AlMn1Fe1 strip cast material.

[Return to Table of Contents](#)